

ISO 6432
PNEUMATIC CYLINDERS
PM-A SERIES Ø8 - Ø25





PM-A SERIES
ISO 6432 - Ø8 - Ø25

DOUBLE ACTING CYLINDER
WITH MAGNET

WITH STAINLESS STEEL ROD AND
TUBE, HIGHER WORKING SPEED



PM-A: DOUBLE ACTING MAGNETIC

Example of order:

<u>PM-A</u>	<u>25-050</u>	<u>SF RC</u>	<u>K1</u>
Product Code	Cylinder Ø Stroke	Cylinder Mountings	Variants from Standard System

VARIANTS FROM STANDARD SYSTEM:

- R1: Stainless Steel Piston Rod (SS 304-SS 316)
- R4: Stainless Steel Nut for Piston Rod (SS 304)
- R5: Piston Rod as CK45 (Hard Chrome Plated)
- M1: Extended male Piston Rod Thread
- M2: Female Piston Rod Thread
- M3: Special Piston Rod Thread
- M4: Extended Piston Rod
- E2: Stainless Steel Cylinder Covers (SS 304-SS316)
- K1: Seals for Max. 150°C (Viton)
- K3: Seals NBR
- K4: Piston Rod Seal Viton

Force:

Cylinder Ø mm	Rod Ø mm	Thrust and traction forces (6 Bar)	
		Thrust Force (N)	Traction Force (N)
8	4	24	15
10	4	41	32
12	6	55	38
16	6	105	88
20	8	165	141
25	10	266	219

Working Fluid:

Filtered and lubricated or filtered and not lubricated air

Operating Temperature Range:

Polyurethane (PU) : (-20°C) - (+80°C)
Viton (FKM) : (-30°C) - (+150°C)

Max. Work Pressure:

10 Bar

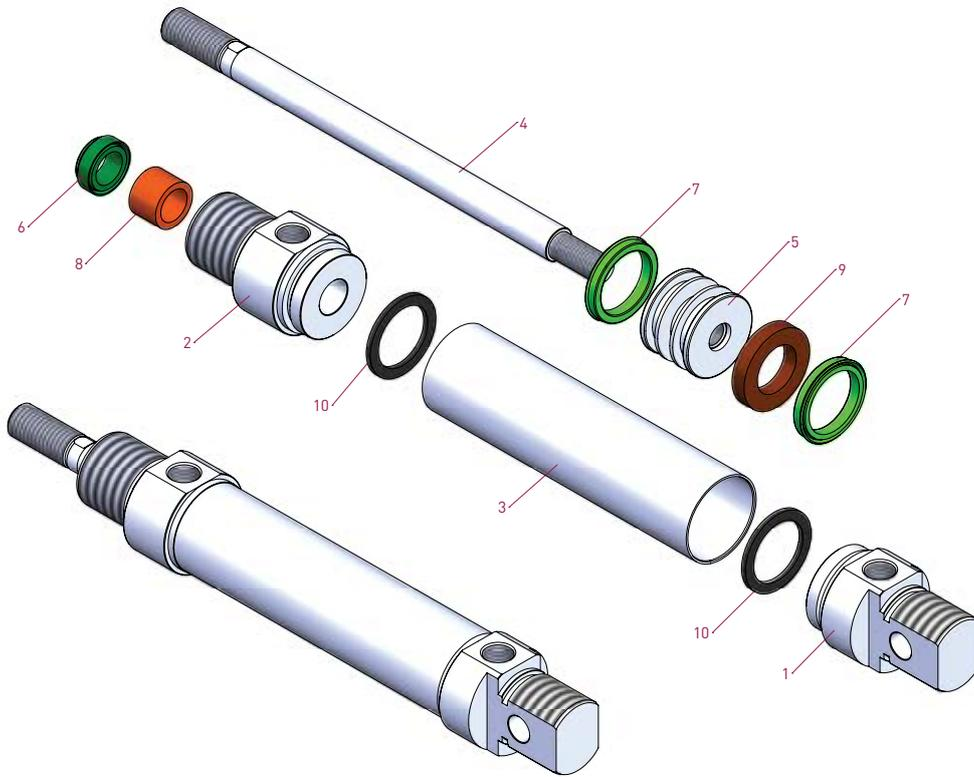
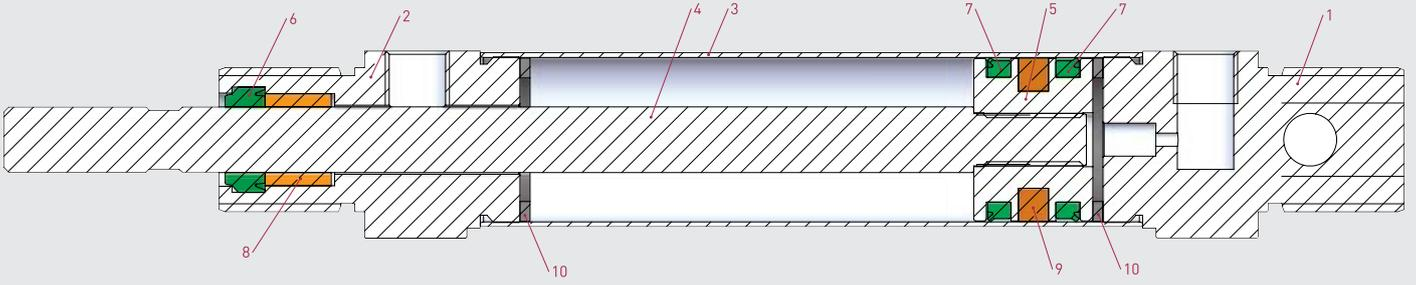

No	MATERIAL NAME	CHARACTERISTIC	PC.
1	Rear Head	Aluminium	1
2	Front Head	Aluminium	1
3	Tube	SS 304	1
4	Piston Rod	SS 303	1
5	Middle Piston	Brass	1

No	MATERIAL NAME	CHARACTERISTIC	PC.
6	Rod Seal	PU	1
7	Piston Seal	PU	2
8	Guidind Bush	Sinterized Bronze	1
9	Magnet		1
10	Buffer	NBR	2

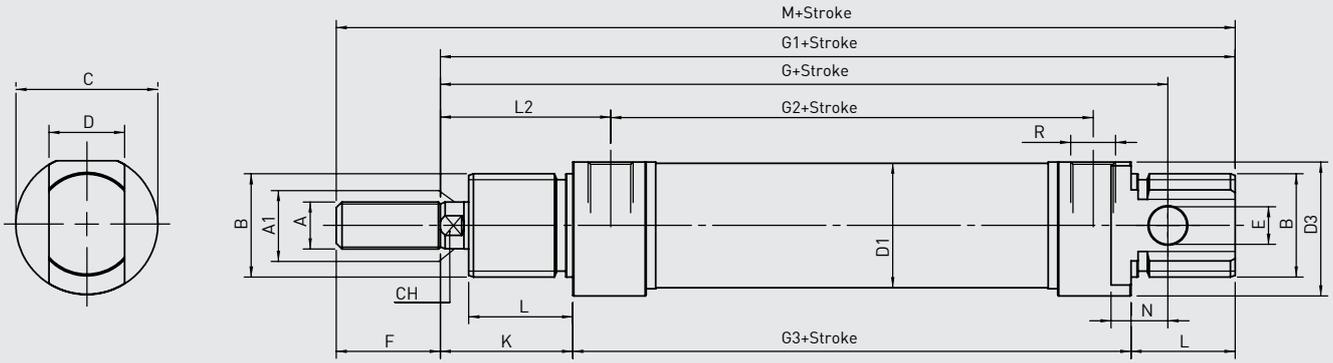

PM-A SERIES
ISO 6432 - Ø8- Ø25

Cylinder Ø mm	A	A1	B	C	D	D1	D3	E	F	G	G1	G2	G3	K	L	L2	N	CH	R	M
8	M4	4	M12x1.25	16	8	9,27	15	4	12	64	74	36	46	16	12	21	6	/	M5	86
10	M4	4	M12x1.25	16	8	11,27	15	4	12	64	74	36	46	16	12	21	6	/	M5	86
12	M6	6	M16x1.5	19	12	13,27	18	6	16	75	88	38	48	22	18	27	9	5	M5	104
16	M6	6	M16x1.5	19	12	17,27	18	6	16	82	93	44	53	22	18	27	9	5	M5	109
20	M8	8	M22x1.5	27	16	21,27	25,5	8	20	95	111	51,5	67	24	20	32	12	7	1/8" G	131
25	M10x1.25	10	M22x1.5	30	16	26,5	28,5	8	22	104	118	52	68	28	22	36	12	9	1/8" G	140

SF SWIVEL FLANGE

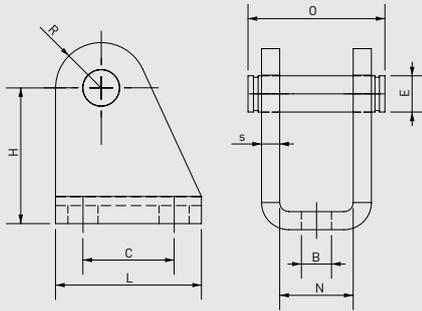

Cylinder Ø mm	B H13	E f8	C JS13	H ±0.2	L	N E9	O	R max	S ±0.2
8-10	4,5	4	12,5	24	20	8,1	17	5	2,5
12-16	5,5	6	15	27	25	12,1	23	7	3
20-25	6,6	8	20	30	32	16,1	29,5	10	4

FM FLANGE MOUNTING

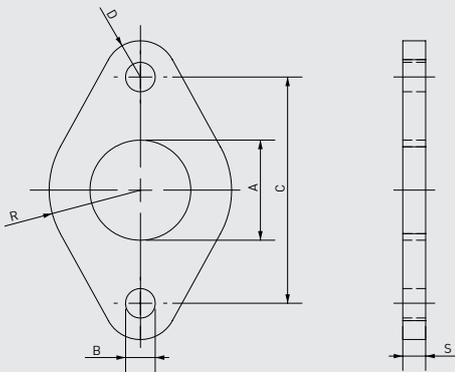

Cylinder Ø mm	A +0.3 +0.1	B H13	C JS13	R ±0.2	G ±0.2	S ±0.2
8-10	12	4,5	30	11	5	3
12-16	16	5,5	40	15	6	4
20-25	22	6,6	50	20	8	5

FM FOOT MOUNTING

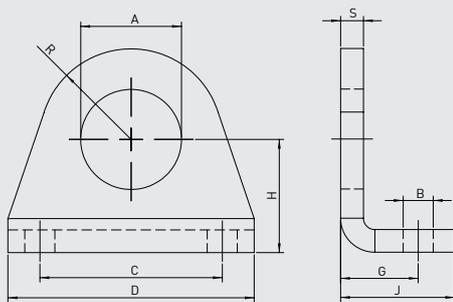

Cylinder Ø mm	A +0.2 +0.1	B H13	C JS13	D	G +0.3 0	H ±0.2	J	R max	S ±0.2
8-10	12	4,5	25	35	11	16	16	10	3
12-16	16	5,5	32	42	14	20	20	12,5	4
20-25	22	6,6	40	54	17	25	25	20	5

RC ROD CLEVIS

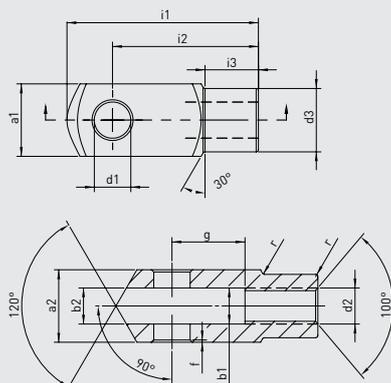

Cylinder Ø mm	d1 H9	g ±0.5	a1 h11	a2 +0.3 -0.16	b1 B13	b2	d2 6H	d3 ±0.3	f ±0.2	i1 ±0.5	i2	i3 ±0.2	r
8-10	4	8	8	8	4	4	M4x0.70	8	0,5	21	16	6	0,5
12-16	6	12	12	12	6	6	M6x1.00	10	0,5	31	24	9	0,5
20	8	16	16	16	8	8	M8x1.25	14	0,5	42	32	12	0,5
25	10	20	20	20	10	10	M10x1.25	18	0,5	52	40	15	0,5

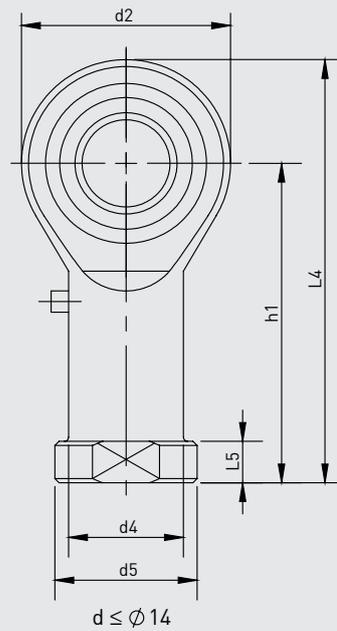
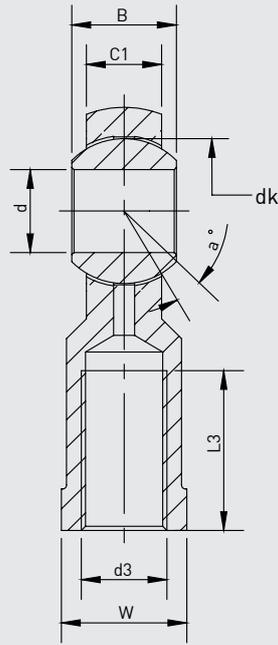

Part No.	Dimensions (mm)													
	d	d3 6H	B	C1	w	L3 min	d2	L4	h1	L5	d4	d5	dk	a°
KMB 6	6	M6x1.0	9	6,75	11	12	18	39	30	5	10	13	12,7	13
KMB 8	8	M8x1.25	12	9	14	16	22	47	36	5	12,5	16	15,875	14
KMB 10-1	10	M10x1.25	14	10,5	17	20	26	56	43	6,5	15	19	19,05	13